

SPARE PART CATALOGUE | ATV70

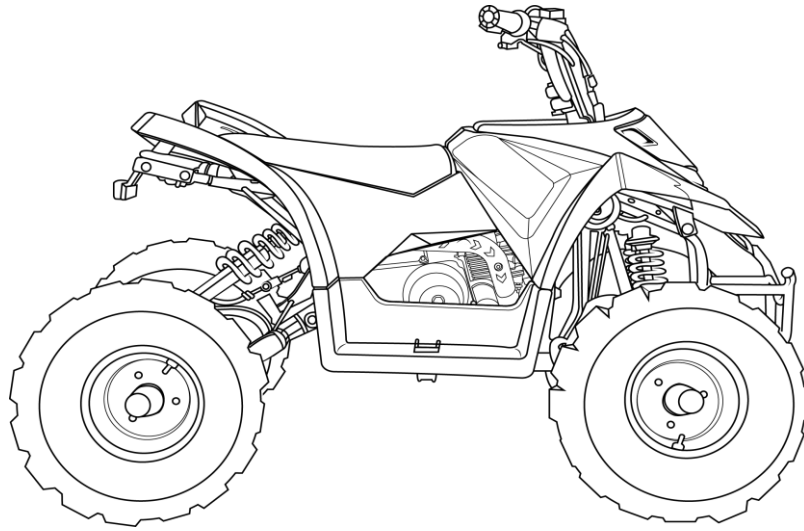

CHASSIS

A - Assembly

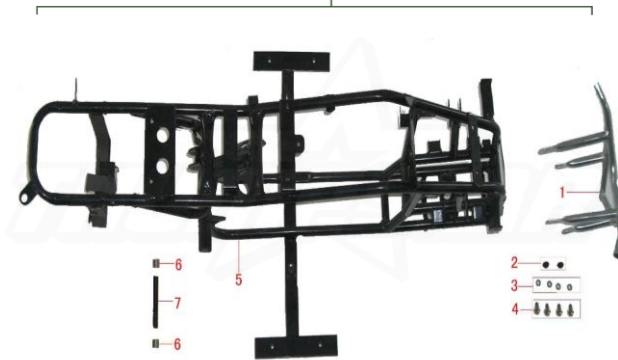

POS	PART NO.	ENGLISH NAME	QTY	NAME	SPECIFICATION
A		Complete Assembly			
1	1.4.06.0020	bumper	1	保险杠	
2	1.4.02.1010	Bumper block	2	保险杠堵头	
3	0.04.00710	WASHER 8	4	弹垫8 发黑	
4	0.01.05120	Bolt M8*16 yellow zinc plated	4	螺栓M8*16 镀锌	
5	1.1.06.0012	frame	1	车架	
6	1.3.02.0050	spacer washer for rear swingarm	2	后平叉减震套	
7	1.3.06.0030	sleeve for rear swingarm	1	后平叉内衬管	

PLASTIC COVERS

A - Assembly

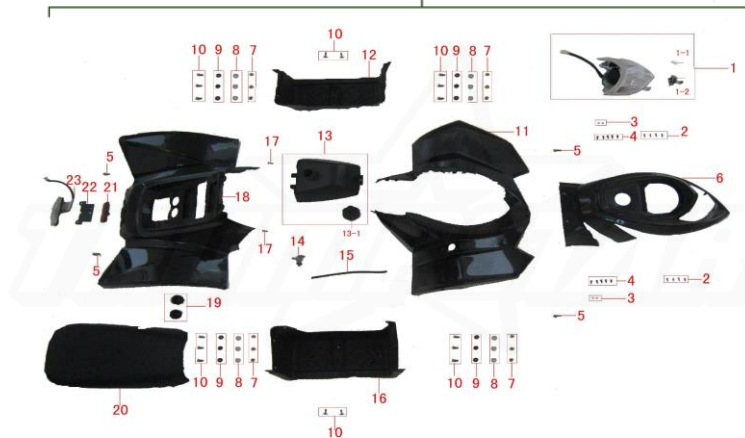

POS	PART NO.	ENGLISH NAME	QTY	NAME	SPECIFICATION
-----	----------	--------------	-----	------	---------------

A	Complete Assembly			
1	5.2.06.0010	headlight	1	前大灯
1-1	5.2.02.0110	bulb for small headlight	2	小灯灯泡
1-2	5.2.06.0020	bulb for big headlight	1	前大灯灯泡
2	0.02.02650	cross recess head screw ST4.2*14	8	十字槽盘头自攻螺钉ST4.2*14 镀白锌
3	0.04.01650	washer 4	4	垫片4 镀白锌
4	0.02.02650	cross recess head screw ST4.8*14	10	十字槽盘头自攻螺钉ST4.2*14 镀白锌
5	0.01.00420	bolt M6*16 yellow zinc plated	2	螺栓 M6x16 镀彩锌
6	6.2.06.005001	front panel (black)	1	前面板 (黑)
	6.2.06.005003	front panel (red)	1	前面板 (红)
7	0.03.02920	Nut M6	12	螺母M6 (防滑)
8	0.04.00150	washer 6	12	垫片6 镀白锌
9	6.2.02.0130	307 rubber washer	12	307橡胶垫
10	8.1.02.0030	mashroom head bolt M6*16	16	大扁头螺栓M6*16
11	6.2.06.003001	front body cover (black)	1	前车主体 (黑)
	6.2.06.003002	front body cover (red)	1	前车主体 (红)
12	6.2.06.0010	footrest left	1	左脚踏板
13	2.9.06.0010	fuel tank assy	1	油箱总成
13-1	2.9.06.0020	fuel tank cap	1	油箱盖
14	2.9.06.0030	switch for fuel tank	1	油箱开关
15	2.9.02.0030	fuel pipe	1	油管
16	6.2.06.0020	footrest right	1	右脚踏板
17	0.01.00420	bolt M6*16 yellow zinc plated	2	螺栓 M6x16 镀彩锌
18	6.2.06.004001	rear body cover (black)	1	后车主体 (黑色)
	6.2.06.004002	rear body cover (red)	1	后车主体 (红)
19	6.1.04.0020	washer for seat	2	坐垫避震块
20	6.1.06.0010	seat	1	坐垫
21	5.2.02.0050	rear reflector (red)	1	后反射器 (红)
22	1.4.02.0040	bracket for taillight	1	尾灯安装支架
23	5.2.02.0011	taillight	1	后尾灯

REAR SWINGARM

A - Assembly



POS	PART NO.	ENGLISH NAME	QTY	NAME	SPECIFICATION
A		Complete Assembly			
1	2.3.02.0030	chain 420-76	1	链条420-76	
2	0.03.00850	nut M14*1.4	1	螺母M14*1.4 镀白锌	
3	1.3.06.0051	Bolt M14*1.5*230 for rear swingarm	1	后平叉安装螺栓M14*1.5*230	
4	4.1.06.0140	abrasion-resistant cover	1	耐磨套	
5	4.1.06.0150	spacer washer abrasion-resistant cover	1	耐磨套衬套	
6	1.2.02.0081	Steel sheet washer	2	皮钢垫圈	
7	1.3.06.0011	rear swingarm	1	后平叉	
8	0.03.02250	locknut M8	2	锁紧螺母M8 镀白锌	
9	0.04.00350	washer 8	2	垫片8 镀白锌	
10	4.1.03.0120	rear jack	2	千斤	
11	0.03.00520	Nut M10*1.25	2	螺母M10*1.25 镀彩锌	
12	4.2.06.0021	Rear shock absorber	1	后减震	
13	0.01.07420	Bolt M10*1.25*42	2	螺栓M10*1.25*42 镀彩锌	
14	4.3.02.0013	rear hydraulic disc brake	1	后液压碟刹	
14-1	5.3.02.0250	cable for brake switch	1	刹车开关线束	
14-2	4.3.02.0030	brake pads	1 set(2 Pcs)	碟刹摩擦片	
15	0.01.00920	bolt M8*20 yellow zinc plated	13	螺栓M8*20 镀彩锌	
16	0.03.00120	nut M8 yellow zinc plated	6	螺母M8 镀彩锌	
17	4.1.02.0251	rear wheel hub	2	后轮毂	
18	4.1.02.1310	sprocket 420-37	1	链轮盘420-37	
19	4.1.02.0031	Housing for sprocket	1	链轮盘座	
20	4.1.02.0012	rear axle	1	后轴	
21	4.1.02.0061	seat for brake disc	1	刹车盘座	
22	4.1.02.0073	brake disc	1	刹车盘	
23	4.1.02.0130	dustproof washer	2	防尘垫片	
24	0.04.03050	washer 14*28*2	1	垫片14*28*2 镀白锌	
25	0.03.01620	slotted nut M14*1.5	2	开槽螺母M14*1.5 镀彩锌	
26	0.08.02100	cotter pin 2.5*30	2	开口销2.5*30	

FRONT SUSPENSION

A - Assembly

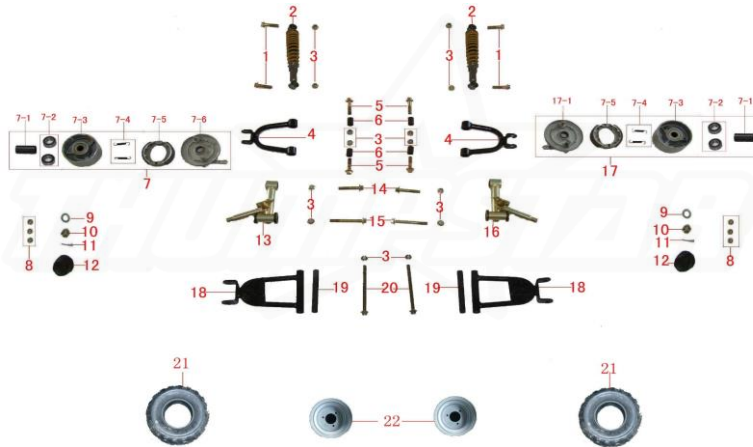

POS	PART NO.	ENGLISH NAME	QTY	NAME	SPECIFICATION
A		Complete Assembly			
1	0.01.07420	Bolt M10*1.25*42	4	螺栓M10*1.25*42 镀锌	
2	4.2.06.0011	front shock absorber	2	前减震	
3	0.03.00520	Nut M10*1.25	14	螺母M10*1.25 镀锌	
4	1.3.02.0010	Up A-arm	2	上摇臂	
5	0.01.05620	Bolt M10*1.25*45	4	螺栓M10*1.25*45 镀锌	
6	1.3.02.0070	Sleeve for top A-arm	4	上摇臂内衬管	
7	4.3.02.0180	front left drum brake assy	1	左前鼓刹组件	
7-1	4.1.02.0221	sleever for front wheel hub	2	前轮毂内衬管	
7-2	0.05.01400	modified bearing 6003Z	4	轴承6003Z	
7-3	4.3.02.0130	front drum brake body	2	前刹刹体	
7-4	4.3.02.0160	spring for front drum brake	4	前刹刹弹簧	
7-5	4.3.02.0070	brake shoes for front drum	4	前刹刹摩擦片	
7-6	4.3.02.0140	left side cover of drum brake	1	刹刹左盖	
8	0.03.00120	nut M8 yellow zinc plated	6	螺母M8 镀锌	
9	0.04.03050	washer 14*28*2	2	垫片14*28*2 镀锌	
10	0.03.01620	slotted nut M14*1.5	2	开槽螺母 M14x1.5 镀锌	
11	0.08.02100	cotter pin 2.5*30	2	开口销2.5*30	
12	4.1.02.0100	dustproof cover for wheel	2	防尘套	
13	3.1.06.0020	Y-bone left	1	左羊角组件	
14	0.01.04620	Bolt M10*1.25*55	2	螺栓M10*1.25*55 镀锌	
15	0.01.04320	Bolt M10*1.25*85	2	螺栓M10*1.25*85 镀锌	
16	3.1.06.0030	Y-bone right	1	右羊角组件	
17	4.3.02.0190	right drum brake assy	1	右前鼓刹组件	
17-1	4.3.02.0150	right cover for drum brake	1	刹刹右盖	
18	1.3.06.0021	down A-arm	2	下摇臂	
19	1.3.03.0050	sleeve for down A-arm	2	下摇臂内衬管	
20	0.01.07220	Bolt M10*1.25*155	2	螺栓M10*1.25*155 镀锌	
21	4.1.02.0180	front tyre 16/8-7	2	前轮胎16/8-7	
22	4.1.02.0490	rim 7"	2	轮毂 (7寸)	

ELECTRICALS

A - Assembly



POS	PART NO.	ENGLISH NAME	QTY	NAME	SPECIFICATION
A		Complete Assembly			
1	5.3.02.0370	key switch	1	电门锁	
2	5.3.04.0092	voltage	1	高压包	

2-1	5.3.04.5000	cap for voltage	1	高压包帽	
3	5.3.02.0070	ignition	1	点火器	
4	0.01.00320	Bolt M6*12	1	螺栓M6*12 镀锌	
5	0.03.00220	nut M6	1	螺母M6(防滑)	
6	5.3.02.0081	regulator	1	稳压器	
7	5.3.02.0050	relay	1	继电器	
8	5.3.02.0062	emergency switch	1	紧急熄火开关	
9	5.3.06.0015	main cable	1	电缆总成	
10	5.3.02.0290	fuse	1	保险丝	
11	2.1.02.0024	70cc engine	1	90cc自动波发动机	
11-1		engine assembly	1	发动机组件(裸机)	
11-2	380070004-0001	Bolt M6*8	2	螺栓M6*8 镀锌 8.8级	
11-3	0.04.04930	washer for gear	1	小飞安装垫片	
11-4	2.1.02.1160	flywheel 420-14	1	小飞420-14	
11-5	0.01.00500	bolt M6*32	2	螺栓M6*32 镀锌 8.8级	
11-6	7.6.0033	engine side cover	1	发动机链条盖	
11-7	2.1.02.1320	oil level gauge	1	机油尺	
11-8	0.01.11350	bolt M6*20	2	螺栓M6*20 镀锌 8.8级	
11-9	2.8.02.0021	intake pipeXS60	1	进气管XS60	
11-10	7.6.9004	rubber washer for intake pipe	1	进气管胶垫	
11-11	380070080-0005	BOLT,HEXAGONAL WITH FLANGE	2	六角头螺栓	
12	5.3.21.0040	battery (12V 9AH)	1	电池 (12V 9AH)	
12-1	7.6.9003	bolt for the battery	1	电池安装螺栓	
13	0.01.00420	bolt M6*16	1	螺栓M6*16 镀锌	
14	6.2.06.0060	battery cover	1	电池盒盖	
15	6.2.07.0060	belt for battery	1	电池扣带	
16	2.8.03.0013	carburetor PZ19L-037e	1	化油器PZ19L-037e	
17	2.5.03.1000	airfilter	1	空滤器	
18	0.03.00120	Nut M8	3	螺母M8 镀锌	
19	0.01.15520	Bolt M8*105	1	螺栓M8x105 镀锌	
20	0.01.05920	Bolt M8*110	1	螺栓M8x110 镀锌	
21	0.03.02350	Nut M6	4	螺母 M6 (加厚) 镀锌	
22	2.4.06.0012	muffler	4	消音器	
22-1	2.4.03.0021	seal	1	石棉垫	
23	0.01.05120	Bolt M8*16 yellow zinc plated	1	螺栓M8*16 镀锌	





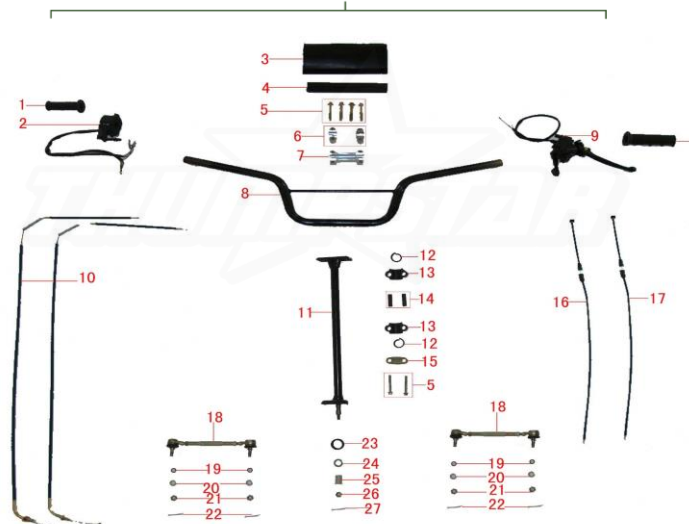







STEERING











A - Assembly



POS	PART NO.	ENGLISH NAME	QTY	NAME	SPECIFICATION
A		Complete Assembly			
1	4.4.02.0030	handle cover(L/R) (black)	2	把手套(黑)	
2	5.3.02.0010	Function button	1	多功能开关	
3	7.5.02.4180	Foam cover 18CM (black with GOES)	1	商标橡皮18CM(黑色, 印GOES)	
4	7.5.02.1750	Foam	1	商标海绵芯	
5	0.01.04720	Bolt M8*55	6	螺栓M8*55 镀锌	
6	4.4.01.0030	HANDLE BAR CLAMP TOP	2	方向把上压块	
7	4.4.01.0050	HANDLE BAR CLAMP BOTTOM	1	方向把下压块	
8	4.4.06.0011	Handle bar	1	方向把	
9	4.3.02.0121	brake lever	1	小孩子刹把	
10	4.5.02.0034	front brake cable	2	刹车拉索	
11	1.2.06.0011	steering assy	1	方向柱	
12	1.2.02.0050	dustproof seal	2	防尘油封	
13	1.2.02.0020	clipper for steering pole	2	方向柱固定夹	
14	1.2.02.0040	sleeve for clipper	2	方向柱固定隔套	
15	1.2.06.0020	fixing panel for steering pole	2	方向柱固定片	
16	4.5.02.0020	choke cable	1	风门拉索	
17	4.5.02.0011	throttle cable	1	油门拉索	
18	3.1.03.0030	tie rod	2	转向拉杆	
19	0.04.00810	WASHER 10	4	弹垫10 发黑	
20	0.04.00450	washer 10	4	垫片10 镀锌	
21	0.03.01820	slotted nut M10*1.25	4	开槽螺母M10 镀锌	
22	0.08.02100	cotter pin 2.5*30	4	开口销2.5*30	
23	1.2.02.0070	dustproof cover for steering pole	1	方向柱油封	
24	0.04.03050	washer14*28*2	1	垫片14*28*2 镀锌	
25	1.2.02.0060	PU cover	1	PU套	
26	0.03.01820	slotted nut M10*1.25	1	开槽螺母M10*1.25 镀锌	
27	0.08.02100	cotter pin 2.5*30	1	开口销2.5x30	

FA-A SERIES OPTIONAL ACCESSORIES

REMOTE CONTROL ALARM				
	PART NO.	QTY	ENGLISH NAME	NAME
	5.4.04.0070	1	Remote control	遥控器
	5.4.04.0060	1	Horn for remote control	报警器
	7.5.06.0550	1(set)	Sticker (only for GOES 90XS)	贴花
CHARGING KIT				
	PART NO.	QTY	ENGLISH NAME	NAME
	5.3.02.0160	1	charging mouth	充电插口
	5.3.02.0181	1	rubber cover for charging (red)	充电插口胶盖
	5.3.02.0220	1	charger	充电器
FLAG				
	PART NO.	QTY	ENGLISH NAME	NAME
	1.1.02.0040	1	flag pole	旗杆
	1.1.02.0070	1	flag	三角红旗
	1.1.02.0080	1	bottom spacer bush	旗杆上固定套
	1.1.02.0090	1	bottom spacer bush	旗杆下固定套
	1.1.02.0110	1	spring for flag pole	扫雷旗杆弹簧
FRONT HYDRAULIC DISC BRAKE ASSMBLY				
	PART NO.	QTY	ENGLISH NAME	NAME
	1.1.02.0040	1	flag pole	旗杆
	1.1.02.0070	1	flag	三角红旗

	1.1.02.0080	1	bottom spacer bush	旗杆上固定套	
	1.1.02.0090	1	bottom spacer bush	旗杆下固定套	
	1.1.02.0110	1	spring for flag pole	扫雷旗杆弹簧	
	1.1.02.0090	1	bottom spacer bush	旗杆下固定套	
	1.1.02.0110	1	spring for flag pole	扫雷旗杆弹簧	
7" WHEEL					
	PART NO.	QTY	ENGLISH NAME	NAME	
	4.1.02.0180	1	tyre16/8-7	轮胎16/8-7	
	4.1.02.0490	1	front rim 7"	前轮辋 (7寸)	
	4.1.02.0500	1	rear rim 7"	后轮辋 (7寸)	
SPROCKET KIT					
	PART NO.	QTY	ENGLISH NAME	NAME	
	4.1.02.1310	1	Sprocket 420-37	链轮盘	
	2.3.02.0030	1	Chain420-76	链条	
OPTIONAL COLORS OF THE BODY COVERS					
POS.	PART NO.	ENGLISH NAME	QTY	NAME	CONDITION
1	6.2.06.003002	front body cover (red)	1	前车衣主体 (红)	WY-02
2	6.2.06.003003	front body cover (blue)	1	前车衣主体 (兰)	WY-03
3	6.2.06.003006	front body cover (burgundy)	1	前车衣主体 (酒红)	WY-06
4	6.2.06.003007	front body cover (silver)	1	前车衣主体 (银色)	
5	6.2.06.003010	front body cover (pink)	1	前车衣主体 (粉红色)	WY-10
6	6.2.06.003011	front body cover (matte leaf camo)	1	前车衣主体 (枫叶亚光迷彩)	WY-A
7	6.2.06.003012	front body cover (light leaf camo)	1	前车衣主体 (枫叶亮光迷彩)	WY-B
8	6.2.06.003015	front body cover (army green)	1	前车衣主体 (军绿迷彩)	WY-E
9	6.2.06.003016	front body cover (blue/white camo)	1	前车衣主体 (蓝白迷彩)	WY-F
10	6.2.06.003017	front body cover (blue/grey camo)	1	前车衣主体 (蓝灰迷彩)	
11	6.2.06.003018	front body cover (pink camo)	1	前车衣主体 (粉红迷彩)	WY-H
12	6.2.06.003021	front body cover (yellow leaf camo)	1	前车衣主体 (枫叶迷彩)	WY-K
13	6.2.06.003029	front body cover (bright yellow)	1	前车衣主体 (嫩黄)	WY-15
14	6.2.06.004002	rear body cover (red)	1	后车衣主体 (红)	WY-02
15	6.2.06.004003	rear body cover (blue)	1	后车衣主体 (兰)	WY-03
16	6.2.06.004006	rear body cover (burgundy)	1	后车衣主体 (酒红)	WY-06
17	6.2.06.004007	rear body cover (silver)	1	后车衣主体 (银色)	
18	6.2.06.004010	rear body cover (pink)	1	后车衣主体 (粉红色)	WY-10
19	6.2.06.004011	rear body cover (matte leaf camo)	1	后车衣主体 (枫叶亚光迷彩)	WY-A
20	6.2.06.004012	rear body cover (light leaf camo)	1	后车衣主体 (枫叶亮光迷彩)	WY-B
21	6.2.06.004015	rear body cover (army green)	1	后车衣主体 (军绿迷彩)	WY-E
22	6.2.06.004016	rear body cover (blue/white camo)	1	后车衣主体 (蓝白迷彩)	WY-F
23	6.2.06.004017	rear body cover (blue/grey camo)	1	后车衣主体 (蓝灰迷彩)	
24	6.2.06.004018	rear body cover (pink camo)	1	后车衣主体 (粉红迷彩)	WY-H
25	6.2.06.004021	rear body cover (yellow leaf camo)	1	后车衣主体 (枫叶迷彩)	WY-K
26	6.2.06.004029	rear body cover (bright yellow)	1	后车衣主体 (嫩黄)	WY-15
27	6.2.06.005002	front panel (red)	1	前面板 (红)	WY-02
28	6.2.06.005003	front panel (blue)	1	前面板 (兰)	WY-03
29	6.2.06.005006	front panel (burgundy)	1	前面板 (酒红)	WY-06
30	6.2.06.005007	front panel (silver)	1	前面板 (银色)	

31	6.2.06.005010	front panel (pink)	1	前面板 (粉红色)	WY-10
32	6.2.06.005011	front panel (matte leaf camo)	1	前面板 (枫叶哑光迷彩)	WY-A
33	6.2.06.005012	front panel (light leaf camo)	1	前面板 (枫叶亮光迷彩)	WY-B
34	6.2.06.005015	front panel (army green)	1	前面板 (军绿迷彩)	WY-E
35	6.2.06.005016	front panel (blue/white camo)	1	前面板 (蓝白迷彩)	WY-F
36	6.2.06.005017	front panel (blue/grey camo)	1	前面板 (蓝灰迷彩)	
37	6.2.06.005018	front panel (pink camo)	1	前面板 (粉红迷彩)	WY-H
38	6.2.06.005021	front panel (yellow leaf camo)	1	前面板 (枫叶迷彩)	WY-K
39	6.2.06.005029	front panel (bright yellow)	1	前面板 (嫩黄)	WY-15