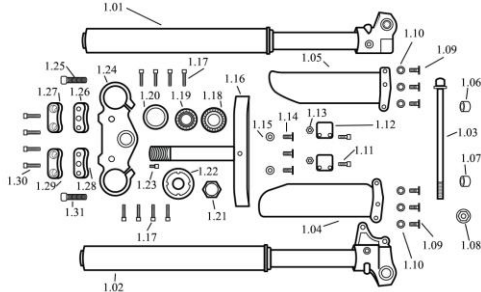
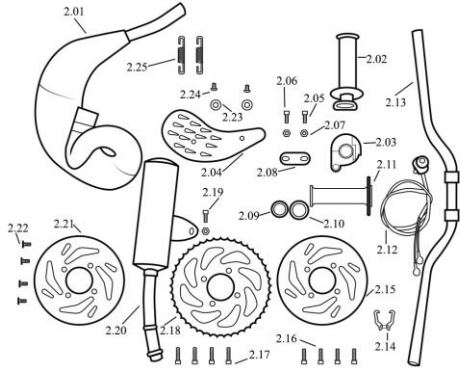
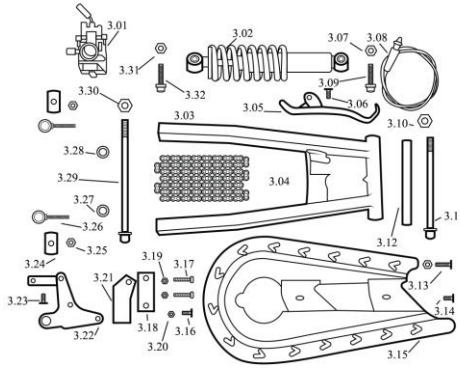
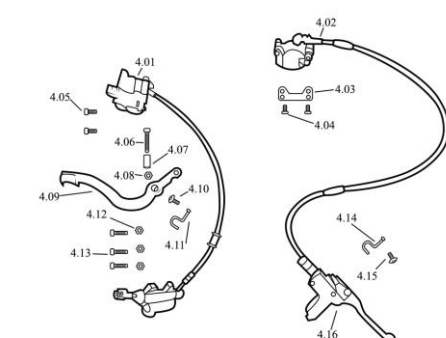

MX 50 SPARE PARTS LIST

	NO	NAME	QTY
	1.01	Front Fork Left Upside Down	1
	1.02	Front Fork Right Upside Down	1
	1.03	Axle 12"205	1
	1.04	Front Fork Cover Right	1
	1.05	Front Fork Cover Left	1
	1.06	Distance Sleeve Left	1
	1.07	Distance Sleeve Right	1
	1.08	Nut M12	1
	1.09	Screw 6"12	6
	1.10	Distance Sleeve	6
	1.11	Screw 6"16	2
	1.12	Retain Clamp For Brake Hose	2
	1.13	Nut M6	2
	1.14	Screw 6"12	3
	1.15	Washer	2
	1.16	Bottom Fork Plate	1
	1.17	Screw 6"25	8
	1.18	Ball Bearing M23	1
	1.19	Ball Bearing Inner M22	1
	1.20	Ball Bearing Outer M22	1
	1.21	Nut M20*1.5 Right	1
	1.22	Covering Cap	1
	1.23	Screw 6"10	1
	1.24	Top Fork Plate	1
	1.25	Screw 10"40	1
	1.26	Handlebar Support Left	1
	1.27	Handlebar Clamp Left	1
	1.28	Handlebar Support Right	1
	1.29	Handlebar Clamp Right	1
	1.30	Screw 8"25	4
	1.31	Screw 10"40	1

	NO	NAME	QTY
	2.01	Exhaust Pipe	1
	2.02	Twist Grip	1
	2.03	Throttle	1
	2.04	Avoid Ironing	1
	2.05	Screw 6"16	1
	2.06	Screw 6"16	1
	2.07	Nut M6	2
	2.08	Fix The Exhaust Pipe	1
	2.09	O Ring	1
	2.10	O Ring	1
	2.11	Rubber Grip	1
	2.12	S.Circuit Button	1
	2.13	Handlebar Aluminium	1
	2.14	Brake Cable Clamp	1
	2.15	Rear Brake Disc	1
	2.16	Screw 8"20	4
	2.17	Sprocket	1
	2.18	Screw 8"25	4
	2.19	Screw 6"16	1
	2.20	Silencer	1
	2.21	Front Brake Disc	1
	2.22	Screw 6"16	4
	2.23	Washer	2
	2.24	Screw 6"10	2
	2.25	Spring	2

	NO	NAME	QTY
	3.01	Carburator	1
	3.02	Rear Shock	1
	3.03	Swing Arm	1
	3.04	Chain	1
	3.05	Chain Slid Guide	1
	3.06	Screw 6"12	1
	3.07	Nut M10	1
	3.08	Throttle Cable	1
	3.09	Screw 10"40	1
	3.10	Nut M12	1
	3.11	Swing Arm Bolt 12"160	1
	3.12	Bushing	1
	3.13	Screw 6"25	1
	3.14	Screw 6"16	1
	3.15	Chain Cover	1
	3.16	Screw 5"10	1
	3.17	Screw 5"35	2
	3.18	Chain Guide Rear	1
	3.19	Nut M5	2
	3.20	Nut M5	1
	3.21	Bracke For Chain Guard	1
	3.22	Fixer For Rear Brake	1
	3.23	Screw 6"12	1
	3.24	Supporting Bracket	2
	3.25	Self Locking Nut M8	2
	3.26	Chain Adjuster	2
	3.27	Distance Sleeve Left	1
	3.28	Distance Sleeve Right	1
	3.29	Axle Rear 12"195	1
	3.30	Nut M12	1
	3.31	Nut M10	1
	3.32	Screw 10"40	1

		NO	NAME	QTY
	4.01	Rear Hydraulic Brake	1	
	4.02	Front Hydraulic Brake	1	
	4.03	Front Brake Fixer	1	
	4.04	Screw 6*10	2	
	4.05	Screw 6*20	2	
	4.06	Screw 8*30	1	
	4.07	Distance Sleeve	1	
	4.08	Nut M6	1	
	4.09	Rear Brake Lever	1	
	4.10	Screw 6*12	1	
	4.11	Brake Hose Clamp	1	
	4.12	Nut M6	3	
	4.13	Screw 6*20	3	
	4.14	Brake Hose Clamp	1	
	4.15	Screw 6*12	1	
	4.16	Handbrake Lever	1	

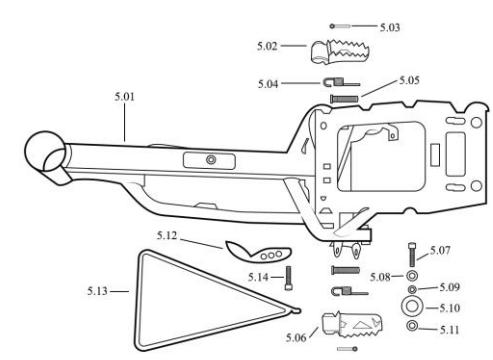
		NO	NAME	QTY
	5.01	Frame	1	
	5.02	Footrest Right	1	
	5.03	Pin 3.2*25	2	
	5.04	Footrest Spring	2	
	5.05	Bolt For Foot Ped	2	
	5.06	Footrest Left	1	
	5.07	Screw 8*30	1	
	5.08	Ball Bearing	1	
	5.09	Bushing 8.2*12*6	1	
	5.10	Chain Roll	1	
	5.11	Ball Bearing	1	
	5.12	Z	1	
	5.13	Side Stander	1	
	5.14	Screw 8*30	1	

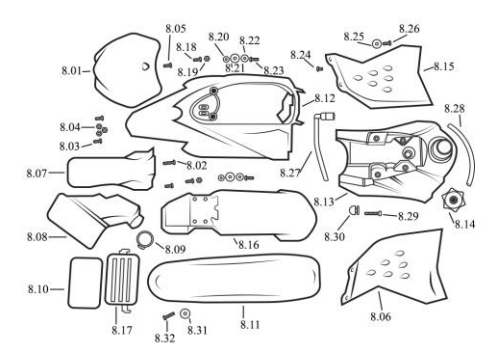
		NO	NAME	QTY
	8.01	Number Plate	1	
	8.02	Screw 6*25	2	
	8.03	Self Locking Screw 5*12	2	
	8.04	Washer	1	
	8.05	Screw 6*12	1	
	8.06	Side Plastic Cover Right	1	
	8.07	Splash Protector	1	
	8.08	Air Filter Tube	1	
	8.09	Hose Clamp	1	
	8.10	Air Filter	1	
	8.11	Seat	1	
	8.12	Rear Fender	1	
	8.13	Fuel Tank	1	
	8.14	Filler Cap Samil	1	
	8.15	Side Plastic Cover Left	1	
	8.16	Fender Front	1	
	8.17	Filter Cover	1	
	8.18	Self Locking Screw 5*12	2	
	8.19	Nut M5	2	
	8.20	Washer	2	
	8.21	Washer	2	
	8.22	Washer	2	
	8.23	Screw 6*20	2	
	8.24	Screw 6*10	4	
	8.25	Washer	2	
	8.26	Self Locking Screw 5*12	2	
	8.27	Fuel Lock	1	
	8.28	Hose	2	
	8.29	Screw 6*40	1	
	8.30	Washer	1	
	8.31	Washer	1	
	8.32	Screw 6*25	1	
	8.33	Tube For Morini Engine	1	

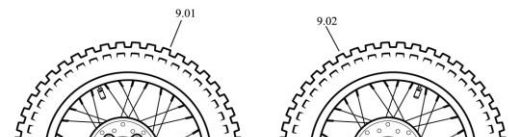
		NO	NAME	QTY
	9.01	Rear Tyre 10'	1	
	9.02	Front Tyre 12'	1	
	9.03	Rear Rim And Hub	1	
	9.04	Front Rim And Hub	1	
	9.05	Rear Wheel Ball Bearing	2	
	9.06	Front Wheel Ball Bearing	2	

